

# Combine Harvesters

MY21 S760, S770, S780, S790 and T670



JOHN DEERE



## It's time to Harvest. Smarter.

The S-Series has a long history of harvesting excellence, and that tradition continues with the S700 Series Combines. We've kept everything you love about the S-Series and made it even better by adding smart, integrated tools so you can harvest smarter.

Whatever the conditions or the operator, the S700 Series Combines automatically give you consistent grain quality. This gives you the confidence that your combine is compensating for changing conditions, even when you can't see them.

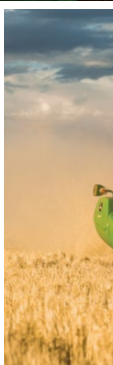



CONTENTS

- S-Series Combines..... 4-5
- Harvesting Precision Ag..... 6-13
- Cab / Controls ..... 14-15
- Feederhouse ..... 16
- TriStream Rotor ..... 17
- Small Grains Packages ..... 18
- Variable Stream Rotor..... 19
- Cleaning Systems ..... 20-21
- Active Tailings System / Grain Handling..... 22-23
- Residue Management..... 24-27
- Transmission / Tracks..... 28-29
- Engine ..... 30
- Service / Parts / Attachments ..... 31
- T670 Small Grain Combine ..... 32-33
- Specifications / Tracks / Tyres ..... 34

# High-quality grain starts with an S-Series



The S700 Combines are the result of engineering more innovation into your harvest:

- 2012** – Variable Stream rotor  
Premium cab  
Premium residue system
- 2013** – 8-wing Feed Accelerator and Stone Trap (FAST)
- 2014** – Interactive Combine Adjustment
- 2015** – Active Concave Isolation  
Feederhouse fore-aft platform tilt
- 2017** – DynaFlo™ Plus Cleaning Shoe  
Active Terrain Adjustment
- 2018** – Combine Advisor™, ActiveYield™, 4600 CommandCenter display
- 2019** – John Deere Tracks, Remote View and Adjust
- 2020** – 5 years of JDLink™ Connect as standard, Redekop Seed Control Unit (SCU)
- 2021** – Grain tank updates, additional unloading auger configurations

## ELIMINATE MANUAL CALIBRATION

Save time with ActiveYield.  
See page 8

## INTEGRATED TECHNOLOGY

It's easier than ever to collect, view, analyse and share valuable data.  
See pages 10-11

## NEW FRONT END EQUIPMENT OFFERING

Including new Hinged Drapers, RDF HydraFlex™ Drapers, CR and CF Corn Heads, and a BP15 Belt Pickup.





### MORE AUGER HEIGHT

Get up to 30 cm (12-in.) additional auger height for more productive unloading.

See page 23

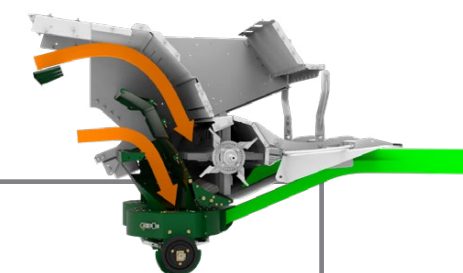

### HARVEST WEED SEED CONTROL

With the fully integrated Redekop Seed Control Unit (SCU).

See page 27

### HIGH QUALITY SAMPLE AND LOW LOSS

With the Combine Advisor package with ActiveVision™ Cameras.

See page 7

### RESIDUE IMPROVEMENTS

Auto Swap enables on-the-go residue direction changes and save time switching between crops with in-cab knife bank adjustment.

See pages 24-26

## Combine Advisor™

Further improve grain quality and reduce losses with the optional Combine Advisor package. It automatically compensates for changing conditions like wet straw and weeds, even if you can't see them.

This package maintains the performance settings you choose — no matter the moisture or crop conditions. You can set it and forget it and your combine will continue to make adjustments as you harvest.

1. **Get your combine set**
2. **Select the Combine Advisor button on the run screen**
3. **Turn on Auto-Maintain**
4. **Select the Set Performance Target button**

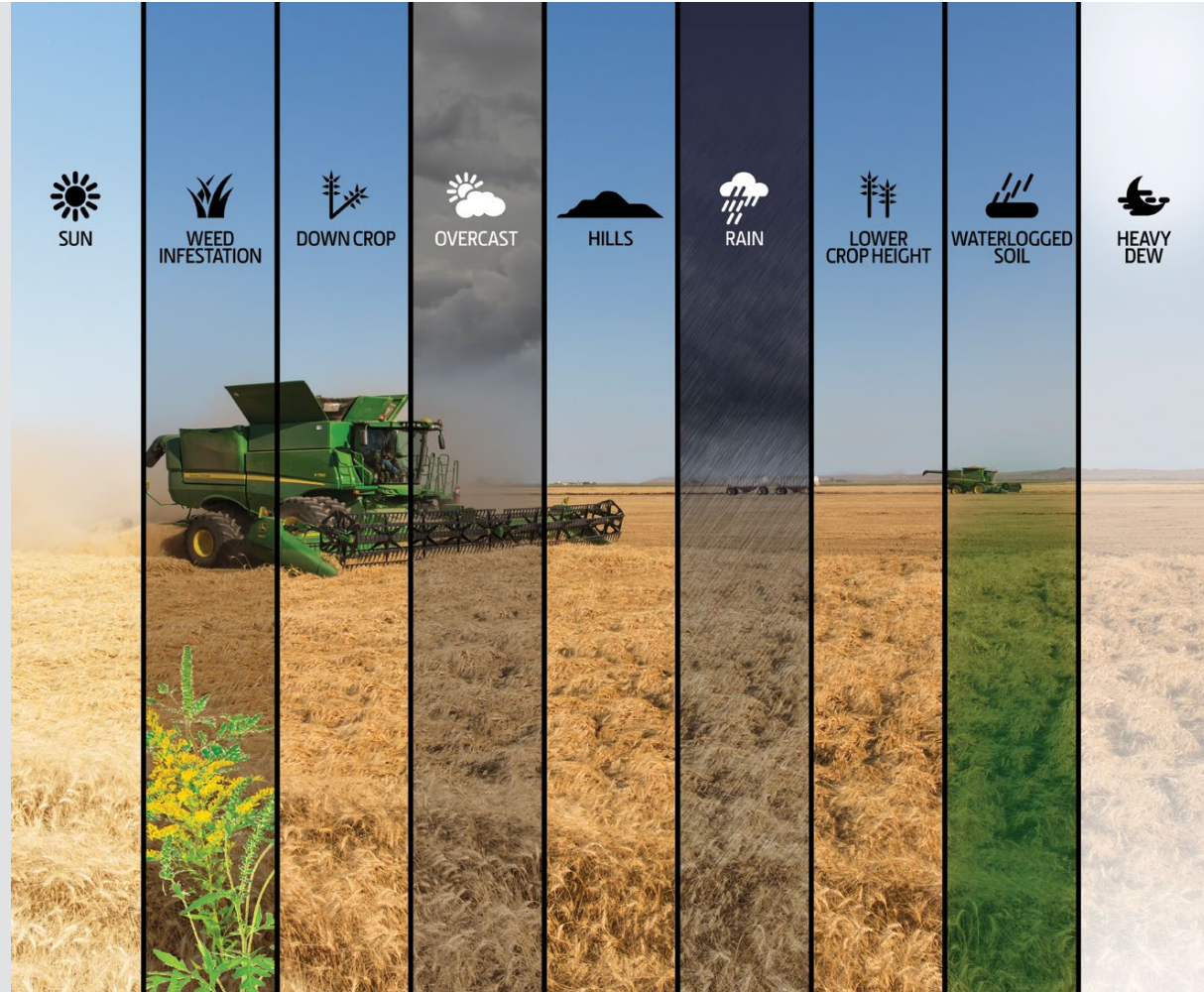

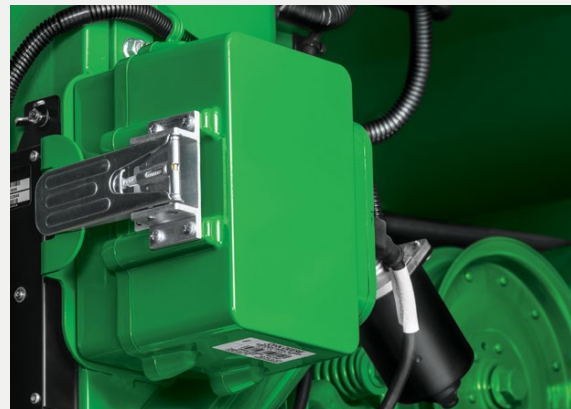
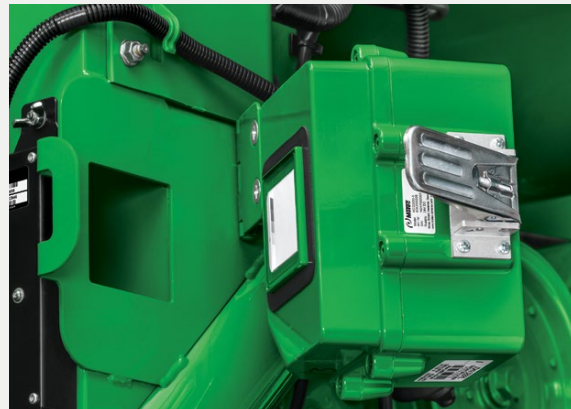
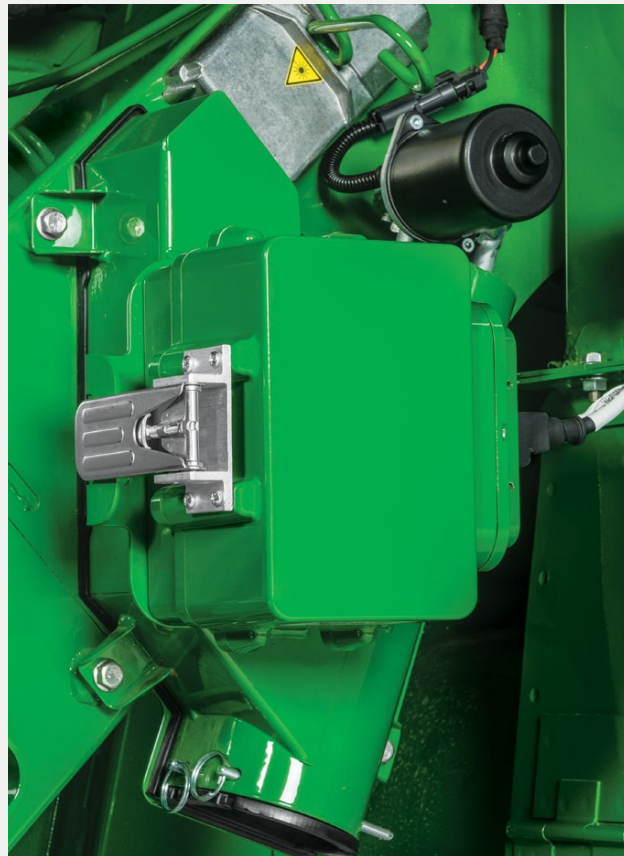

## ActiveVision™ Cameras

Seeing is believing with the ActiveVision Cameras. Two cameras — one on the clean grain elevator and another on the tailings elevator — show grain samples in near-real time. A grain analysis feature shows grain quality and foreign material. You can have confidence the cameras, which work with Combine Advisor, are improving the grain sample, even on-the-go as conditions change.

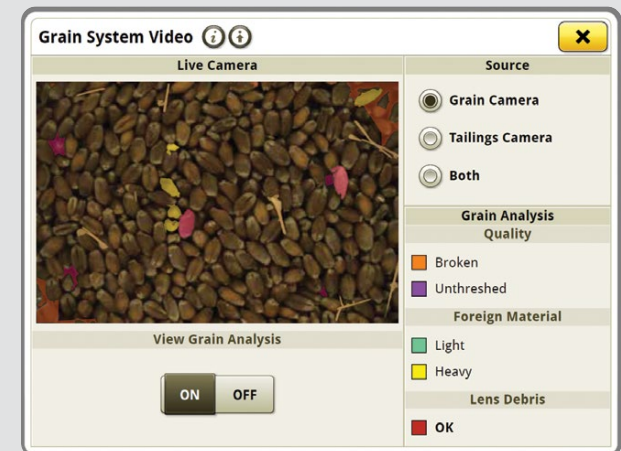

## Save time and make better decisions

Less time calibrating means more time spent harvesting. ActiveYield™ delivers automatic yield calibrations every time you fill up the grain tank, removing the need to spend time manually calibrating. This system ensures your field's yield data will be accurate so you can make decisions with confidence.

ActiveYield is standard on all model year 2021 S700 for use in wheat, barley, canola, corn, soybeans and rice.

### ActiveYield Retrofit Kit

The ActiveYield Retrofit Kit is available for the following combines\*:

- BXE10797 for MY16 to the present is compatible with wheat, barley, canola, corn, soybeans and rice.
- BXE10503 for MY12 to MY15 will be compatible with wheat, barley, canola, corn, soybeans and rice.

*\* Not compatible with S660 or MY18 S760s with manual grain tank extensions.*







## JDLink™ and John Deere Connected Support

Your S700 Combine comes with 5 years of JDLink Connect\* as standard and 5 years of John Deere Connected Support. JDLink Connect opens an automatic, wireless information pipeline between you and your equipment. Agronomic data like yield maps and as-applied data can be accessed away from the field and shared with your advisors. And sending it from the field wirelessly and automatically can prevent you from losing data.

With John Deere Connected Support, distance is no longer a barrier to keep you up and running. With a suite of industry leading tools exclusive to John Deere, we are there for you when you need us most.

### Remote Display Access

Reduce the need for a callout. Your technician can connect virtually in cab to assist you with troubleshooting, optimisation and setup.

### Service ADVISOR™ Remote

Your technician can remotely analyse your machine's Diagnostic Trouble Codes in real time to isolate potential issues. We will send the right technician with the right parts and tools on board to get the job done in the shortest time possible.

### Expert Alerts

We can predict certain potential failures before they occur using advanced algorithms. This allows us to respond quicker to reduce downtime and maximise productivity.

*\*Activation/subscription required. Some additional accessories and/or components may be required. JDLink requires a mobile connection to transfer information from machine to JDLink website. Consult your local John Deere Dealer for coverage availability.*

## Make next year's harvest even better

Your yield data is only useful if you can easily access and share it. That's where the John Deere Operations Center comes in. With it, you can turn your data into information that will make next year's harvest even better.

Store field locations, track the progress of your machines, assign work orders to your operators, view yield and moisture maps as well as create, analyse and share harvest reports with trusted advisors and customers.

With more than 150 software connected software tools, including the major farm management systems used by agronomists, Operations Center ensures you can choose to transfer your data to who you want and when you want.





## Like having your farm in your pocket

Sometimes you just need your information at your fingertips. Whether you're driving grain to the silos or watching your kid's footy game, you can get the information you need about your operation with our mobile apps.

### MyOperations™

Manage your harvest from anywhere with the MyOperations app. Remotely view harvest information such as yield, moisture, and area worked. And you can now remotely view and adjust combine settings: concave clearance, rotor speed, fan speed, chaffer clearance, and sieve clearance. Plus, you can leverage historical map layers, as well as harvest summary information.

### Connect Mobile

Being able to make decisions about next year's crop based upon an evaluation of this year's crop performance during harvest is a valuable tool. Connect Mobile lets you view two live maps for a single field so you can determine what worked well and what did not, all while harvesting.

Apps are available on iTunes® or Google Play™ store.

## For the best harvest – just add guidance

No matter the crop, the AutoTrac\* assisted steering system is the extra set of hands you need during harvest. With accuracy levels ranging from +/- 15 cm down to +/- 2.5 cm, AutoTrac takes your harvesting efficiency to the next level. University research\*\* shows automatic guidance pays for itself in 2 years or less. And when you add in how much better you feel at the end of a long, but hands-free day of harvesting, you'll know it's worth it. And since model year 2019, AutoTrac is included as standard.

### AutoTrac RowSense™

And for corn growers, AutoTrac RowSense delivers AutoTrac accuracy in down corn, around terraces or on pivots, by fusing GPS data from the StarFire™ Receiver with mechanical feeler data from the row sensors. AutoTrac RowSense improves harvest efficiency and yield quality, which lets you harvest at consistent speeds, even around curves.



\* Activation required. Some additional accessories and/or components may be required.

\*\*Auburn University, 2010.



## Share and sync

With Gen 4 Machine Sync\*, you get an impressive array of precision tools to help your harvest run more smoothly. To start, Machine Sync creates a network between a fleet of tractors and combines that helps automate on-the-go unloading by allowing the combine operator to control the movement of the tractor and grain cart. You also get in-field logistics like grain tank fill status and location of all combines and tractors in the network.

In-field data sharing also let you easily see where another combine has already been and share yield maps between combines. And with guidance line sharing, multiple combines can share the same A-B line, reducing the time it takes to set coordinates.

*\*See your dealer for compatibility information.*

## Comfort and control

Our premium cab is the best place to spend long harvesting days. With excellent visibility to your header and crop, you also have everything you need to easily control your machine at your fingertips. The redesigned CommandARM™, along with the new 4600 CommandCenter Display, delivers easy and intuitive harvest run screens. Shortcut buttons let you customise and quickly toggle between run pages. Plus, the Extended Monitor works with your 4600 display to give you more real estate for viewing.

The redesigned multifunction control lever fits your hand perfectly to give you smooth hydrostatic speed control. It also controls unloading operations, AutoTrac resume, and header functions.



If you want even more comfort, add the leather package option, equipped with leather steering wheel, lumbar-supported operator seat that is heated and ventilated, and leather instructor seat.





## S-SERIES COMBINES CAB AND CONTROLS



### Updated Bluetooth feature

Improved Bluetooth speaker delivers better mobile device functionality, keeping you hands-free and focusing on harvesting.



### High standards

Not interested in the leather cab package? No problem. The standard comfort zone cab is still one of the highest in the industry. The air suspension swivel seat adjusts four ways to fit you perfectly. Lumbar adjustment gives you just the right amount of back support. There's even an optional heated cushion. And the seat swivels 15 degrees to the right and 7 degrees to the left for better grain tank and auger visibility.

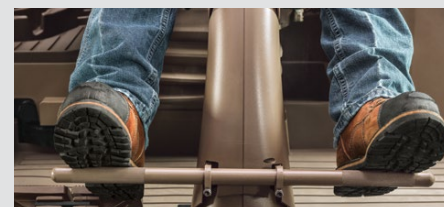

### Footpegs

Included with the premium cab, these footpegs deliver improved comfort during long harvest days.



### More storage

Harvest time means long days in the field, which means you're working and eating on-the-go. Luckily the S-Series cab is big on space and storage. Plus, the integrated refrigerator keeps your refreshments cold all day.

## High-capacity feeding

The **S-Series Combines** have a unique feederhouse design that gives you more than enough capacity to take full advantage of the extra productivity you get with these machines, and lets you handle the increased width and weight of the larger heads with ease and confidence.

The **feederhouse** on the S-Series provides large areas of clearance for high volumes of crop to flow uninterrupted, without hesitation. It's all about matched capacity. You can expect better engagement of crop, earlier, plus a smooth transition from corn head or platform to the feederhouse chain. The 5-speed feederhouse drives uses a high-torque slip clutch and 101 kW (135 hp) reverser, for more matched capacity.



### What's an hour worth to you?

Better yet, what's several hours worth? Over the course of an entire harvest, an hour a day can really add up. With the convenient platform tilt option you can lengthen your harvest day by as much as an hour, and cut off significant time on the back end of the season.

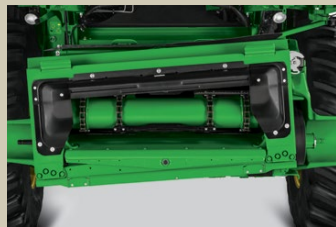

### Lateral tilt feederhouse – Take control of header tilt

**Harvest more grain at faster speeds – in any terrain.** The lateral tilt feederhouse is a self-leveling system that allows the feederhouse and header to tilt 4 degrees side-to-side, hugging the hills. Sensors on all platforms and corn heads detect changes in the terrain and signal the lateral tilt controller. Tilt response is instantaneous.

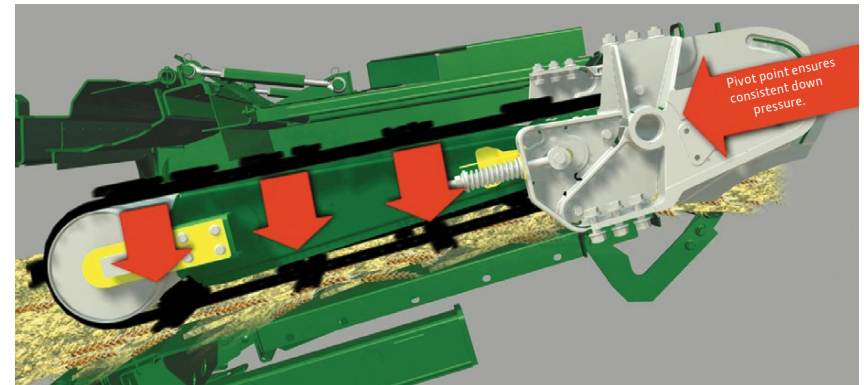

- **High-capacity feederhouse.** Provides a productivity boost for your John Deere S-Series Combine.
- **5-Speed Feederhouse Drive.** The durable high-torque slip clutch ensures peak performance and a long life cycle.
- **Better visibility.** The long feederhouse design gives you a full view of the header and the height-of-cut without having to lean forward. You can also see the stubble height behind the header.
- **Feederhouse reverser.** The robust reverser makes light work of stubborn plugs.
- **Single-lever multi-coupler.** Hooking up headers doesn't get much easier than this.
- **Easy adjustments.** The front plate can be adjusted fore and aft to compensate for different tire sizes, crops, and conditions, ensuring easy transition from the header every time.



## Smooth operation – TriStream™ Rotor

**The best of both worlds...** high capacity and gentle threshing. That's why the TriStream stands out to small grain, soybean and corn growers.

**The TriStream Rotor** features a slightly tapered front nose, which dramatically reduces the 'growling' that often comes with thick crops and heavy rotor loads. The spiral vanes surrounding the rotor guide the crop material through the feeding and threshing area, reducing hesitation and improving productivity.



**Dual-range separator-drive** gives you a wide range of speeds to match conditions. High range provides 380 to 1,000 rpm; low range offers 210 to 550 rpm. Shift one lever to change ranges.

**TriStream Rotor Technology reduces the force required to move material through the combine by as much as 20 percent.** This easier, smoother crop flow reduces the potential for rotor 'growling' at high feedrates, even in damp conditions. This is especially beneficial when harvesting early or late in the day, or any time conditions impair crop flow.

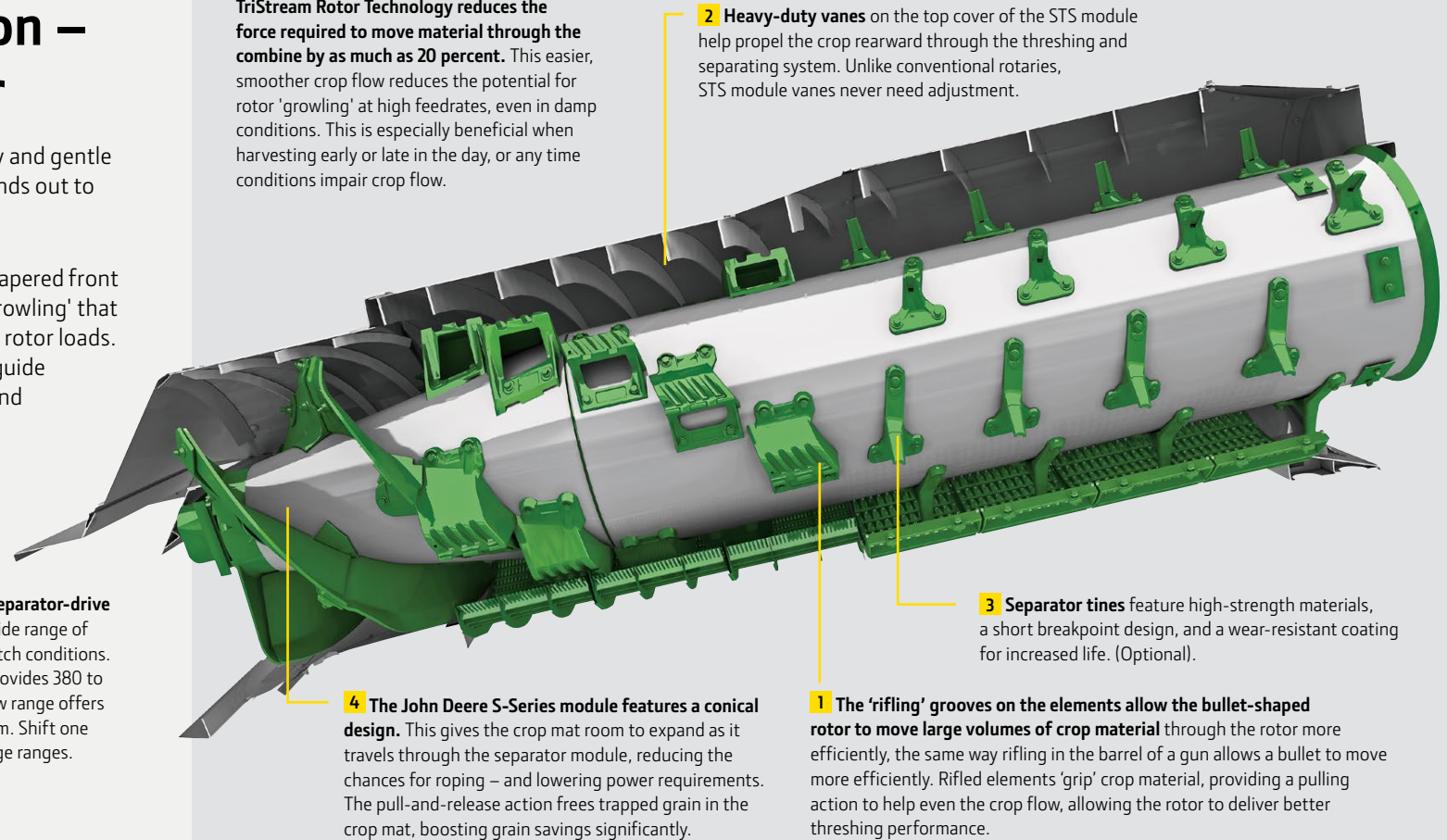

**2 Heavy-duty vanes** on the top cover of the STS module help propel the crop rearward through the threshing and separating system. Unlike conventional rotaries, STS module vanes never need adjustment.

**3 Separator tines** feature high-strength materials, a short breakpoint design, and a wear-resistant coating for increased life. (Optional).

**1 The 'rifling' grooves on the elements allow the bullet-shaped rotor to move large volumes of crop material** through the rotor more efficiently, the same way rifling in the barrel of a gun allows a bullet to move more efficiently. Rifled elements 'grip' crop material, providing a pulling action to help even the crop flow, allowing the rotor to deliver better threshing performance.

**4 The John Deere S-Series module features a conical design.** This gives the crop mat room to expand as it travels through the separator module, reducing the chances for roping – and lowering power requirements. The pull-and-release action frees trapped grain in the crop mat, boosting grain savings significantly.

**Optional extended-wear separating package** includes factory-installed extended-wear concaves, extended-wear threshing elements and separator tines, and extended-wear rotor top covers.

# Raise your throughput by up to 20%

## With tough small grains and rice packages

Truly tough conditions demand more than simple solutions. Rather than slightly improve performance in rice, canola, wheat, barley, oats or other tough small grains, we developed packages where your productivity will soar beyond current limitations — an increase of up to 20%.

How? Four crucial components – (1) Active Concave Isolation, (2) high-performance feederhouse, (3) heavy-duty separator grates with two rows of interrupter bars, and (4) 8-wing feed accelerator. Now, imagine a storm is on the radar and you don't have much time to spare. Thanks to this new package, you can go full throttle and still put your tough crop into the machine without any hiccups.



### 1 High-performance feederhouse

The front feed drum provides you with 51 mm (2 in.) of additional movement for greater flexibility when dealing with challenging crop.

### 2 Active Concave Isolation

In the past, concaves have all been mechanically suspended. Not any longer. Active Concave Isolation now applies hydraulic pressure to better secure the concave. This helps provide extra stability when harvesting really tough crops.

### 3 Heavy-duty separator grates (with interrupter bars)

Heavy-duty separator grates offer higher wear life and greater uptime for challenging conditions. And the dual-row interrupter bars help break up crop mat for superior separation.

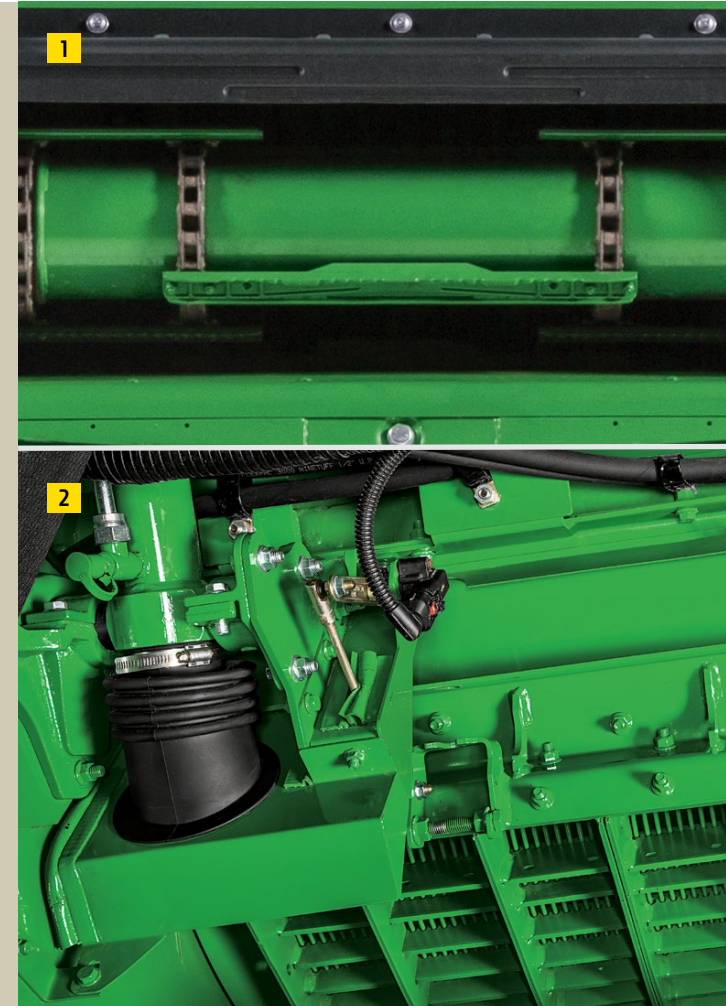

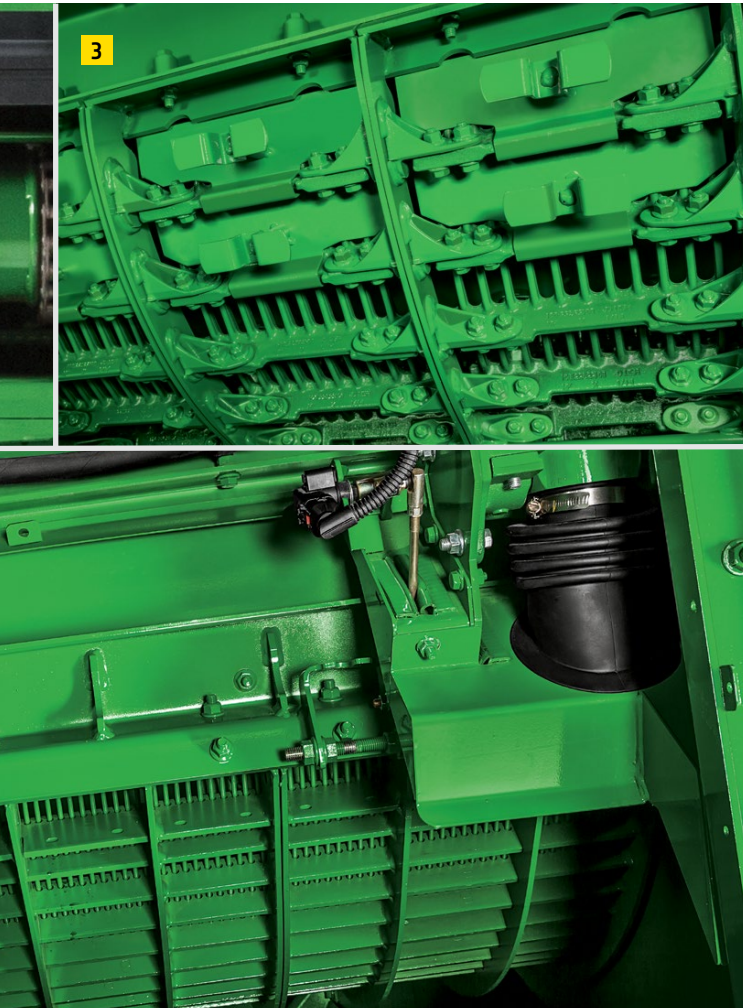

## Variable Stream Rotor

Building on the proven performance of our TriStream rotor, we've added another opportunity for our small grain and rice operators – the Variable Stream rotor. It too delivers high capacity and smooth performance.

The longer, more tapered front cone design makes this rotor well-suited for rice, where conditions are damp, wet, or extremely green. The rotor is also recommended for small grains where straw is tough. The vane angle can be adjusted to reduce the stress on straw material as it flows around the rotor, increasing the quality of the straw.

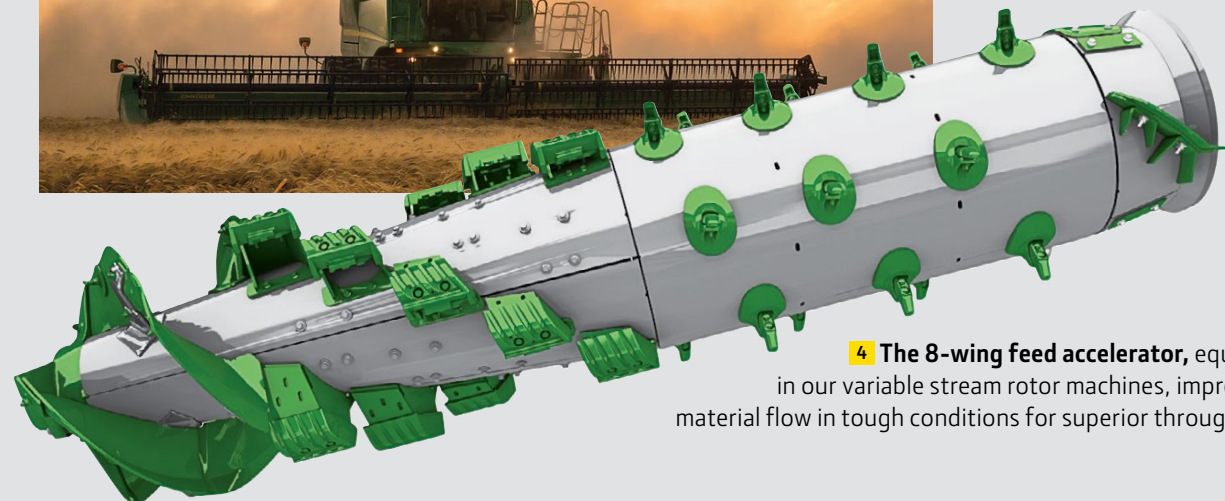

**4** The **8-wing feed accelerator**, equipped in our variable stream rotor machines, improves material flow in tough conditions for superior throughput.

## Dyna-Flo™ Plus Cleaning Shoe

### Consider your capacity needs met

You want more cleaning capacity? We've got it with the S-Series. Lighter in weight and longer in sieve (12% increase in surface area since model year 2017), the Dyna-Flo Plus Cleaning Shoe improves capacity like you wouldn't believe.

In shoe-limited conditions, capacity is raised 13% in wheat and canola and 10% in corn. Also, thanks to the additional capacity, you get more than half a hectare per hour of added time. The Dyna-Flo Plus Cleaning Shoe also knocks down your tailings by as much as 28% to raise your overall speed and productivity. Simply put, this is a cleaning system that does it all.

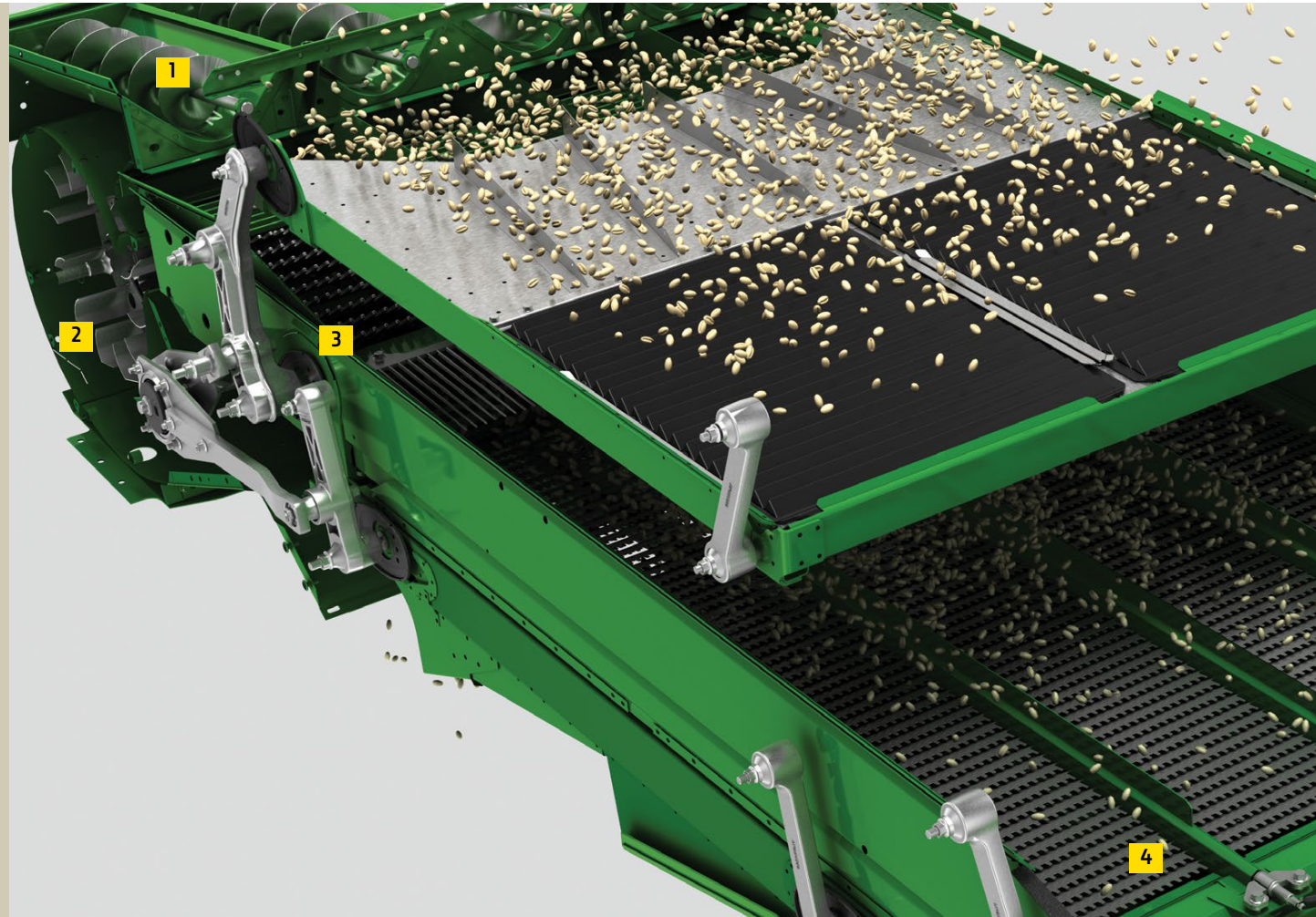
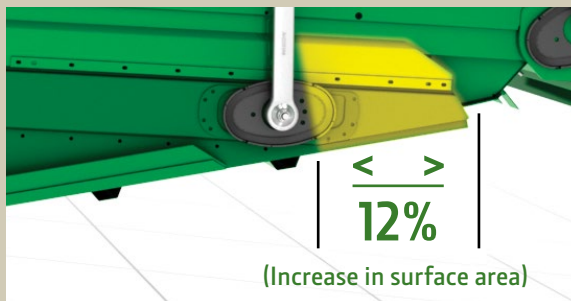



**1 Uniform distribution**

Four conveyor augers move material onto the shoe steadily and evenly, even on hillsides.

**2 Improved fan performance**

The fan ensures peak performance and a clean grain sample. A steep pressure curve delivers high pressure with less volume loss. About 30% of the air goes to the front chaffer at high speed; the rest goes to the rear chaffer and sieve.

**3 Two-stage pre-cleaning**

The fixed front chaffer helps thin the crop mat; the raised front chaffer pre-cleans up to 40% of the free grain before it reaches the main chaffer.

**4 Extended design for more capacity.**

The huge rear chaffer and bigger sieve are specially designed to handle the threshing and separating performance of the new S-Series.



**The shoe drive features an improved belt** that offers double the cross-section of our previous belt and provides twice the tensile strength to tackle the toughest harvesting conditions. For even greater durability and uptime, the bearings, pulleys, and supports have all been upgraded, as well.



**The dual chaffer adjustment** offers improved grain tank cleanliness and greater tailing performance.

# Active Tailings System

## Lowering Losses

Higher capacity with a gentle touch. If you run a large combine and work a lot of hectares, then you'll appreciate the Active Tailings System on the S780 and S790 models. By handling returns that might normally go back to the separator, consuming its performance, it distributes the grain and material back onto the return pan, not to the threshing area, and increases the total capacity of your machine. Better still, it's easy to adjust. Our Active Tailings System uses less aggressive concave settings than the ones in your separator – and handles sensitive crops gently, maintaining grain quality.

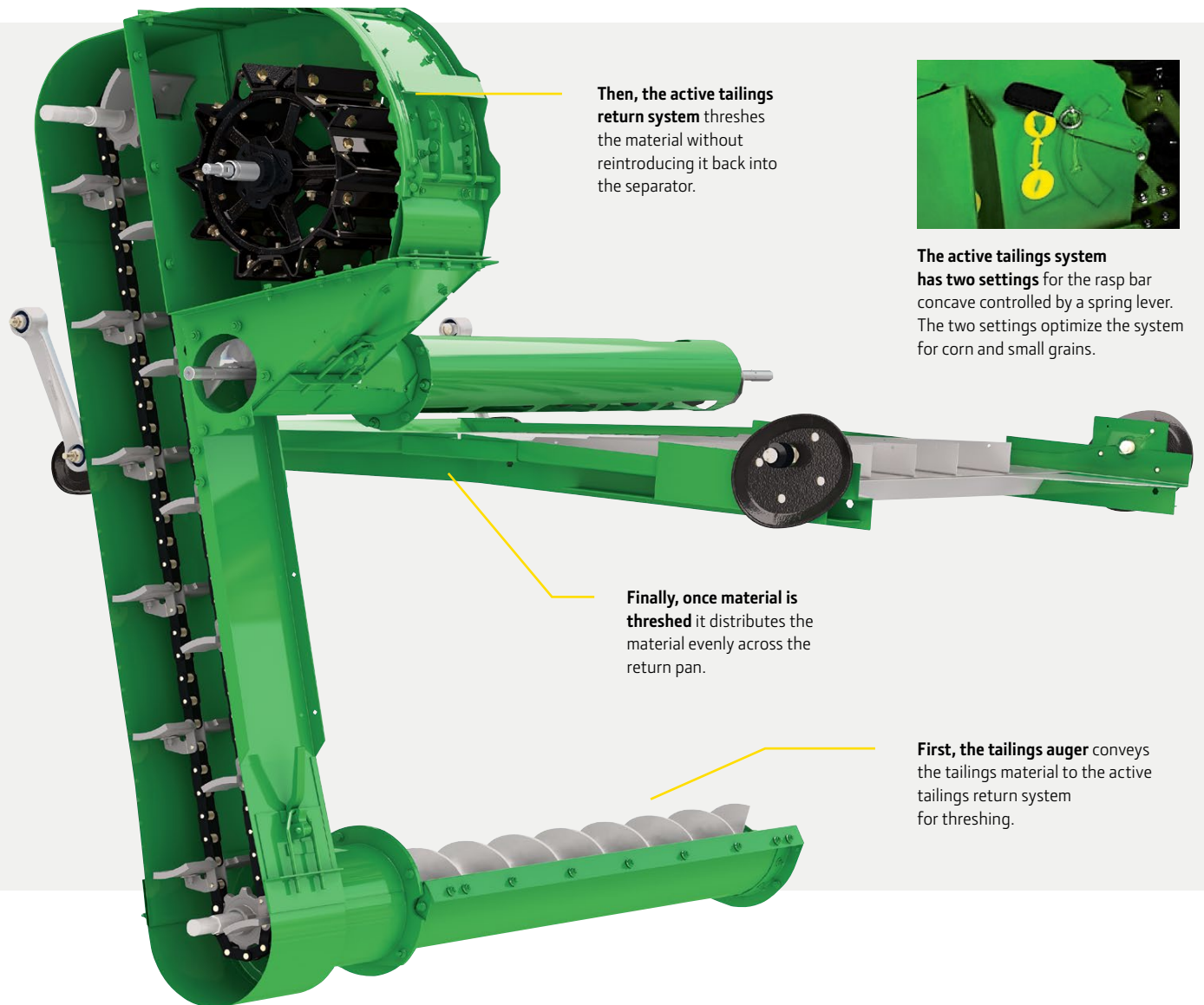
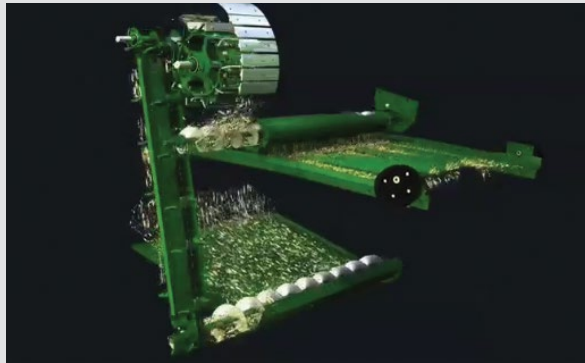

Then, the active tailings return system threshes the material without reintroducing it back into the separator.



The active tailings system has two settings for the rasp bar concave controlled by a spring lever. The two settings optimize the system for corn and small grains.

Finally, once material is threshed it distributes the material evenly across the return pan.

First, the tailings auger conveys the tailings material to the active tailings return system for threshing.



## Grain handling capacity that keeps you running

High yields and tough schedules necessitate a clean grain handling system that can keep up with your harvesting pace. Here's how the S-Series Combines Dyna-Flo Plus Cleaning Shoe deliver:

**14,100 L (400 bu.) grain tank** – Our S780 and S790 machines boast a 14,100 L capacity, in order to attain matched capacity with available front-end equipment.

**Fast delivery** – 105 seconds (that's 134 L/second) is all it takes to empty the 14,100 L grain tank that's standard on the S780 and S790.

**Increased unload height and better handling** – With up to an additional 30 cm (12-in.) of unloading height, you have more room for unloading in those uneven parts of the field. And the optional 7.9 m (26 ft.) rigid unloading auger pairs ideally with the 12.2 m (40 ft.) platforms and 18-row corn heads, making unloading on-the-go a stress-free operation. With the 8.7 m (28.5 ft.) unloading auger, we've extended reach by almost a metre.

**A different kind of cleaning system.** While your cleaning shoe handles your grain, our on-board air compressor will keep the outside of your machine looking neat and like-new. Located in the engine compartment, the air compressor offers a quick and convenient way to keep your combine free of debris, which helps with the uptime of your machine.

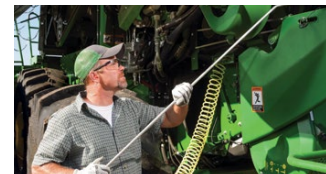

## Residue handling, made flexible

There's a choice of up to three different chopper systems to suit your harvesting operation. Whatever you choose, you can rely on evenly spread fine cut straw from the moment you start harvesting, or well windrowed straw for quality bales.

Our Premium and Intermediate systems are available with a 100 knife, extra fine cut chopper. This ensures the residue is quickly incorporated into the soil, releasing valuable nutrients for the next planting season. The Premium system is also a real time-saver. You can switch from chop to drop from the cab at the touch of a button. It proves a very useful feature at headlands or parts of the field which need to be treated differently.



**Perfect Windrows.** The straw bumper kit slows down the straw as it's expelled by the discharge beater. The result is a fluffy windrow which dries faster so you can bale sooner.



### Deluxe

- Fine cut – 44 rotating and 44 stationary counter knives
- Two manually-adjustable speeds for small grain and corn
- 3-minute manual conversion between chopping and dropping
- Chaff is distributed through the line-break chopper or is dropped below the windrow. No separate chaff spreader needed.
- No overshot beater and therefore less power required, and less weight compared to premium chopper
- Manually adjustable vane tailboard – or PowerCast™ tailboard

### Intermediate

- Extra fine cut – 100 knife chopper producing one of the finest cuts of straw on the market
- Two manually-adjustable chopper speeds for small grain and corn
- 3-minute manual conversion between chopping and dropping
- Chaff is distributed through the chopper in chopping mode or dropped below the windrow in windrow mode; with this chopper, you cannot spread the chaff when you are windrowing
- No overshot beater and therefore less power required, and less weight compared to the Premium chopper
- Advanced PowerCast tailboard

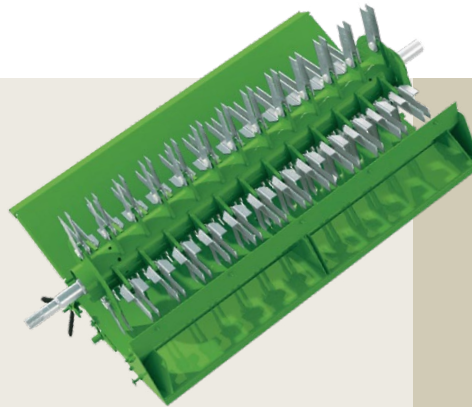

### Premium

- Fine cut – 44 rotating and 44 stationary counter knives or Extra fine cut – 100 knife chopper, producing one of the finest cuts of straw on the market
- Two manually-adjustable chopper speeds for small grain and corn
- Chop-to-drop from cab – switch from chopping straw to dropping windrows at the touch of a button
- In chopping mode, chaff and straw are distributed through the chopper. In dropping mode, chaff is distributed through the chopper and straw is windrowed. No separate chaff spreader is needed.
- Cleaning shoe blows chaff out to the side, away from the windrow, for better quality bales that are free of chaff
- Advanced PowerCast tailboard

	Deluxe	Intermediate	Premium
Chopper type	Fine Cut	Extra Fine Cut	Fine Cut / Extra Fine
Knives	44	100	44 / 100
Chopper, rpm	2,500	3,000	2,500 / 3,000
Manual Adjust Vane tailboard	●	x	x
PowerCast™ tailboard	Optional	x	x
Advanced PowerCast™ tailboard	x	●	●
Overshot beater with straw slide	x	x	●
Remote chop to drop	x	x	●

\*See specifications for compatibility information.

## Residue management systems

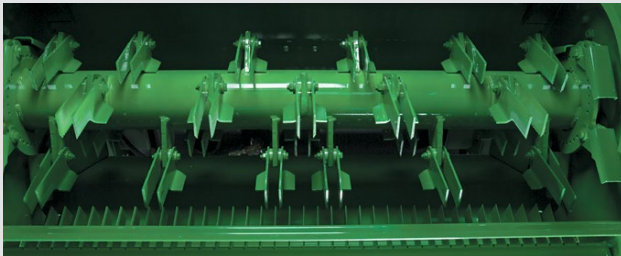

The **Manual Adjust Vane tailboard** design is perfect for spreading residue in widths to 9.1 m (30 ft.). This system is easy to swing up and out of the way for windrowing.

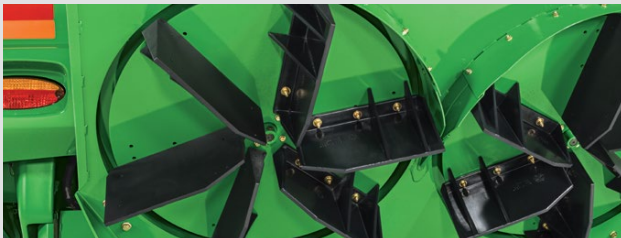

The **PowerCast™ tailboard** provides an effective way to manage residue disposal on your wider platforms. PowerCast evenly spreads residue 9.1 to 15.2 m (30 to 50 ft.) to help with even crop emergence, especially in no-till farming. PowerCast is hydraulically powered and mounts to the rear of the chopper, but all you have to do is relax in your operator seat to set the speed of the system: it's controlled by a button on the CommandArm.



The **Advanced PowerCast™ tailboard** is an option of the premium residue system that gives you additional residue management flexibility. The Advanced PowerCast tailboard contains two hydraulically driven enclosed discs and a center divider that moves back and forth in a pendulum motion. There's also in-cab shroud adjustment for wind compensation.

### With the premium residue system you can:

- Chop straw and chaff, and then spread both by making adjustments within the cab
- Form a straw windrow while chopping and spreading chaff
- Form a straw and chaff windrow without chopping material
- In-cab shroud adjustment for wind compensation



All three residue management options allow you to make on-the-go crop residue management changes as conditions warrant by changing knife bank position from the cab.



## Combat weed seeds at harvest

Mechanically control harvestable weed seeds in a single pass with the optional Redekop™ Seed Control Unit (SCU). Integrated into S780 and S790's residue management, drive, and Gen 4 CommandCenter™ 4600 display, it provides a flexible and cost-efficient solution to devitalise more than 98 percent\* of harvestable weed seeds.

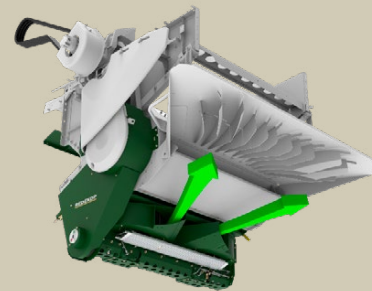
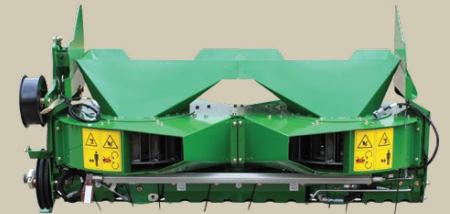

Easily engaged or disengaged without the need for special tools, the SCU utilises proven mechanical drive to direct chaff through reversible mills where seeds are devitalised before being discharged directly into the chopper's residue stream – enabling an improved residue mix and spread while minimising dust. For fields where the SCU isn't needed, within minutes it can be simply disengaged or bypassed completely allowing material to be windrowed or dispersed by the chopper.

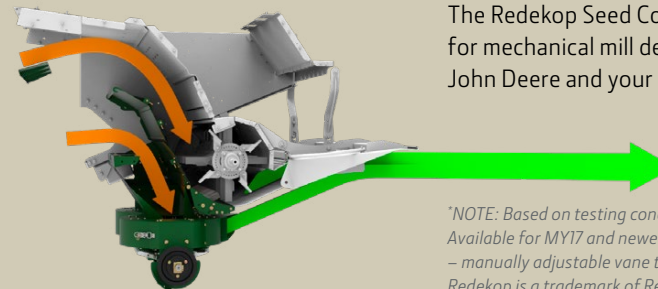

The Redekop Seed Control Unit (SCU) sets a new benchmark for mechanical mill design and is fully supported by John Deere and your local John Deere dealer.

*\*NOTE: Based on testing conducted by Agriculture and Agri-Food Canada (AAFC) 2019. Available for MY17 and newer S780 and S790 Combines fitted with deluxe residue – manually adjustable vane tailboard and deluxe residue – PowerCast tailboard. Redekop is a trademark of Redekop Manufacturing.*



## The ProDrive™ Ground Drive System

Get more precise, more consistent control of your ground speed throughout the travel range of the hydro handle. ProDrive lets you switch between two infinitely variable speed ranges with the push of a button. Using the CommandTouch™ armrest console, set the first range for typical harvesting speeds, and the second for transport.

It reduces your combine's engine RPMs during transport while still maintaining a productive ground speed. The results? Improved fuel savings, helping you increase fuel efficiency.

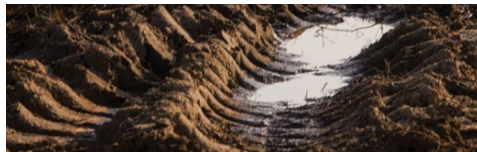

**Another benefit ProDrive delivers:** An electro-hydraulic differential lock with a 4-pinion differential for greater traction in muddy harvesting conditions.

## The right transmission for you

### ProDrive: Automatic efficiency

**Seamless shifting.** When ground conditions change, ProDrive lets you smoothly shift between two speed ranges with the push of a button. You'll no longer have to stop to shift when going up or down hills or exiting fields.

**Speed Selection.** Set one speed for normal harvesting, the other for faster field work or transport. Then select any speed in either range by using the hydrostatic control handle on your CommandARM™ console.

**More torque.** With power to spare, ProDrive makes light work of tough conditions. It delivers 64% more torque at a harvesting speed of 8 km/h.

### Push Button Shift Transmission

**Shifting made easy.** Our three-speed Push Button Shift Transmission makes shifting easy. Simply bring your machine to a standstill, select the gear you need by pressing one of three buttons on the arm rest and let the combine do the rest.

**Comfort and control.** Our Push Button Shift Transmission makes operation easier with features like the automatic park brake. As soon as you pull the hydro level to the neutral position, the park brake is applied giving you more comfort and control and helping you through those long working days.

**Two-speed 4-wheel-drive** lets you switch between torque ranges. In slow-speed mode, the high-torque rear assist is ideal for tough conditions. Use high-speed mode for low-torque performance and faster ground speeds.





The heavy-duty final drive is designed and manufactured with a massive, ductile iron housing that provides high load-carrying capability. Model year 2020 final drive provides the capacity to handle larger high-flotation tyre options as well as wide draper platforms or large corn heads – They also feature new 20 bolt design.



The hydrostatic system includes a variable displacement pump gear driven from the main engine gear case and a variable displacement motor located on the ProDrive™ Transmission. This provides an infinite speed range in each gear and eliminates ground belts, reducing maintenance.



All S-Series Combines are equipped with a rugged, adjustable rear axle to allow variable rear tyre tread widths.

## John Deere Tracks for S-Series Combines

Now your ability to get into your fields sooner is easier than ever. Reach a road transport speed of up to 40 km/h with John Deere Tracks. The suspended track system provides a smoother ride with better ground following. This makes for more comfortable harvesting days and lets you finish faster. These tracks – available with 61 cm, 76.2 cm, and 91.4 cm (24-, 30- or 36-in.) wide belts – deliver better ride quality and ground following, thanks to new suspension cylinder and tandem bogie wheel. The wider track footprint improves flotation and compaction – plus there's no daily maintenance.

John Deere 61 cm and 76.2 cm (24, 30-in.) tracks are suitable for control traffic farming.

## Power of Choice

John Deere PowerTech™ engines provide the ultimate combination of performance, fuel economy, and emissions compliance – delivering constant, reliable power to keep you productive in all harvesting conditions. Model year 2021 S700 are available in Tier 2 or optional Final Tier 4 (FT4). Get uncompromising performance up to 460kW engine power (625 hp) or even higher with Intelligent Power Management (FT4/ Stage V).

### PowerTech

#### Tier 2/Stage II

#### Single Fixed turbocharger

Fixed geometry turbochargers are sized for a specific power range and optimised to provide excellent performance across the entire torque curve. They are also designed to maximise fuel economy between the engine's rated speed and peak torque.

#### High-pressure fuel system

Enables precise control for start, duration and end of injection; controls fuel injection timing and provides higher injection pressures improving combustion, engine performance and reducing emissions.

#### Air-to-air aftercooling

Lowers the intake manifold air temperature promoting more efficient cooling and greater engine reliability.

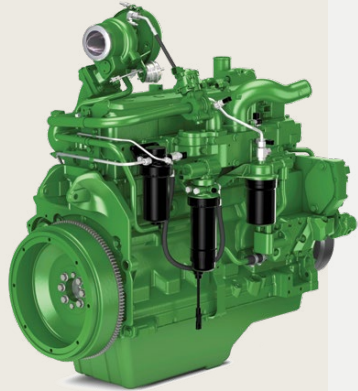

### PowerTech PSS

#### FT4/Stage V

#### Series turbochargers

Deliver higher power, more low-speed torque and engine responsiveness to meet varying load conditions.

#### Variable geometry turbocharger (VGT)

Electronic controls open or close variable vanes depending on load and speed. Optimised airflow generates more boost allowing for quicker load response, increased low-rpm torque, better transient response and improved fluid efficiency.

#### High-pressure fuel system

Enables precise control for start, duration and end of injection; controls fuel injection timing and provides higher injection pressures improving combustion, engine performance and reducing emissions.

#### Air-to-air aftercooling

Lowers the intake manifold air temperature promoting more efficient cooling and greater engine reliability.



#### Cooled exhaust gas recirculation (EGR)

Precise amounts of cooled exhaust gases are mixed with incoming fresh air lowering combustion temperatures. This improves performance and lowers emissions.

#### Selective catalytic reduction (SCR)

This technology utilises a urea based additive referred to as diesel exhaust fluid (DEF). The ammonia in the urea mixes with engine exhaust gases in the SCR catalyst to reduce NOx. The optimisation of cooled EGR and SCR allows John Deere machines to use less DEF than other FT4 solutions.

#### Catalysed exhaust filter with DOC/DPF

Exhaust gases flow through an oxidation catalyst and filter trapping particulate matter. During normal operating conditions the engine's natural heat oxidises the trapped particulate matter and cleans the filter.

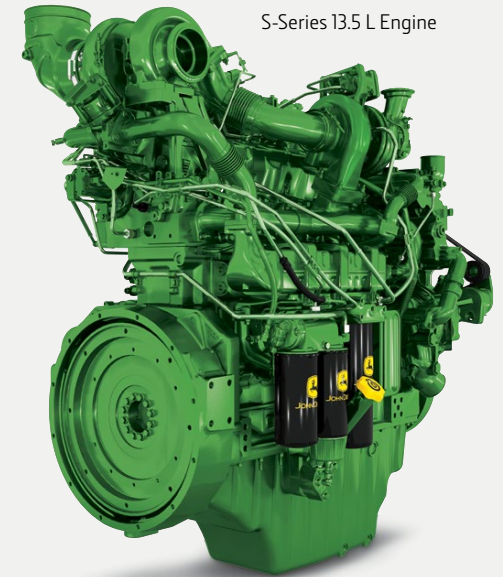
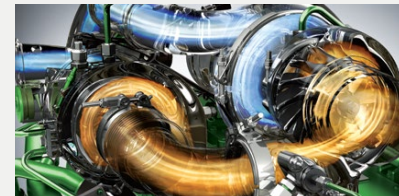

S-Series 13.5 L Engine



S-Series 9.0 L Engine



It doesn't matter if you own a new John Deere combine, an older model, or even equipment that's not green and yellow. With our industry-exclusive selection of parts, your John Deere dealer has the Right Part to fit your needs\*. Get exactly The Right Part at the Right Price – for as long as you own your machine – no matter its color, or your budget. That's **the value of choice**. And you'll only find it at John Deere. See your dealer today.

\* Availability of genuine John Deere parts, John Deere Reman parts and/or A&I parts vary by dealer. See participating John Deere dealer for details.



### Combine Advisor™ Performance Upgrade

With a trio of technologies designed to maximise your harvest, Combine Advisor is available as a field-installed performance upgrade for S700 Series Combines (MY18 and newer). The robust suite helps you target optimal settings and then automates the combine to maintain peak performance in changing conditions. Combine Advisor includes:

- **HarvestSmart™** to automate feed rate
  - **Active Terrain Adjustment™** to manage changing terrain
  - **Auto Maintain w/ActiveVision™** to monitor crop conditions
- BXE11034: ICA2 Attachment Bundle (Package Quantity: 1)
  - BXE11035: ICA2 Attachment Bundle (Package Quantity: 1)
  - BXE10948: Active Terrain Adjustment (Package Quantity: 1)



### ActiveYield Performance Upgrade Kit

ActiveYield is available for crops including: wheat, barley, canola, corn, soybeans and rice. Kits are not compatible with S660 with manual fold extensions or MY18 S760s with manual fold extensions.

- BXE10503 for MY12-15
- BXE10797 for MY16+



### 600D, 700D and 700FD Center Section Seal Kit

The center section seal kit minimises grain loss when direct cutting canola. Reduce center feed section losses on 600D, 700D and 700FD drapers by 45%. For the best performance when harvesting cereal grains, it is recommended to remove the left and right side seal components.



### RowMax™ Row Unit Performance Upgrade Kit

Increase wear life of sprockets and gathering chains by 50%, increase wear life of stalk rolls by 25%.

- KXE10487 – Factory base on 700C/FC; available for retrofit on MY12 and newer 600C/FC's
- RowMax stalk rolls should also be ordered

## Time better spent

### Harvest more acres per day with the T670 Combine

The T670 not only increases your productivity and efficiency, but also improves the quality of your grain and straw – and that’s something you can rely on in every situation. The proven crop flow system doesn’t bend or break your grain or straw and offers improved performance in all crops and all harvest conditions. The advanced threshing and cleaning systems now have the largest surface area of its kind on the market.

The T670 delivers up to 15% more capacity in wheat so you can work faster and more efficiently. And it comes ready to roll with precision ag technology.

The 8.7 m (28.5 ft.) unloading auger matches front end equipment for improved unloading logistics. On the separator, square edge bars have been replaced with rounded bars; eliminating the last three finger rows and extending wires to cover the same area.

An LED lighting package is available for the full machine. Plus, you can drain hydraulic, PTO and engine oil from ground level.







## Better performance and serviceability

The T670 features the largest cleaning shoe of its kind on the market, which enables ease of adjustment and delivers a more stable performance under changing harvesting conditions. With the Dyna-Flo™ Plus cleaning shoe, there are fewer manual and remote adjustments needed to be done by the operator. The new Dyna-Flo Plus cleaning system reduces tailings volume, particularly the amount of threshed grain in the tailings system.

The largest separator of its kind on the market features an unbeatably spacious separation area of 4m<sup>2</sup>. The unique multi-drum threshing system with crops flowing above the overshot beater ensures a consistent crop flow without sharp bends or abrupt changes in direction. For the new T670, we have further extended the threshing concave by 8 degrees, but kept the same angles and interconnection points to ensure excellent grain and straw quality.

Improved serviceability means more time for harvest. With fewer maintenance intervals and improved access to service and maintenance points, you'll spend less time on service tasks. Plus, the T670 comes with an optional, factory-installed air compressor. A 60 L air reservoir with a 10 m hose and 3 air quick coupler points helps keep your combine clean.



For easy changing between crops, one person can change the concave inserts through the stone trap, without removing the feederhouse.



**Fast crop conversion.** The time needed to reconfigure the T670 for optimum performance when changing crops has been reduced by the redesign of the T670 De-awning Plates (Front Concave Closure Plates) and concave Booster Bar. The three articulated plates close the front three concave bars for more intense threshing in hard-to-thresh crops and conditions where white caps are an issue. Positioning of the de-awning plates can be done quickly without the use of tools. Booster bar adjustment also can be done easily and quickly within minutes.

S-SERIES AND T-SERIES COMBINES SPECIFICATIONS

MODEL	S760	S770	S780	S790	T670
<b>ENGINE</b>					
Type	John Deere 6 cyl. 9.0 L	John Deere 6-cyl. 9.0 L	John Deere 6-cyl 13.5 L	John Deere 6-cyl 13.5 L	John Deere 6 cyl. 9.0 L
Displacement (L/cu. in.)	9.0/548	9.0/548	13.5/824	13.5/824	9.0/548
Fuel Capacity (L/gal.)	950/250	950/250	1250/330	1250/330	800/211
Cooling	Air-to-Air Aftercooler	Air-to-Air Aftercooler	Air-to-Air Aftercooler	Air-to-Air Aftercooler	Air-to-Air Aftercooler
Rated Speed (rpm)	2200	2200	2100	2100	2200
Rated Power (kW/hp) @ Rated Speed – FT4/Stage V	249/333	292/391	353/473	405/543	292/392
Power Boost @ Rated Speed (kW/hp) – FT4/Stage V	274/367	317/425	37/50	37/50	25/34
Rated Power @ – 100 rpm Rated Speed (kW/hp) – FT4/Stage V	267/358	313/419	378/507	433/580	n/a
Peak Power @ – 200 rpm Rated Speed (kW/hp) – FT4/Stage V	285/382	335/449*	402/540	460/617	n/a
Rated Power (kW/hp) @ Rated Speed – Tier 2/Stage II	239/320	278/373	353/473	405/543	n/a
Power Boost @ Rated Speed (kW/hp) – Tier 2/Stage II	25/34	25/34	37/50	37/50	n/a
Rated Power @ – 100 rpm Rated Speed (kW/hp) – Tier 2/Stage II	256/343	297/398	378/507	433/580	n/a
Peak Power @ – 200 rpm Rated Speed (kW/hp) – Tier 2/Stage II	273/365	317/425	402/540	460/617	n/a
*S670 Bulge Hp above 425Hp is limited by ECU timer					
<b>FEEDING</b>					
Drive Type	Fixed or Variable	Fixed or Variable or MultiSpeed	Fixed or MultiSpeed	Fixed or MultiSpeed	Fixed
Conveyor Chain Slat Type	Cast Iron	Cast Iron	Cast Iron	Cast Iron	Under shot-slat
Width (mm/in.)	1397/55	1397/55	1397/55	1397/55	--
Length (mm/in.)	1727/68	1727/68	1727/68	1727/68	1850/73
Feed Accelerator, Stone Trap (FAST)	Standard	Standard	Standard	Standard	Standard
Reverser	Standard	Standard	Standard	Standard	Standard
<b>THRESHING/SEPARATING</b>					
Separator Type	Rotary	Rotary	Rotary	Rotary	Multi Drum/Straw Walker
Rotor Length (mm/in.)	3124/123	3124/123	3124/123	3124/123	--
Rotor Diameter (mm/in.)	762/30	762/30	762/30	762/30	--
Rotor Speed Range (rpm)	210-1000	210-1000	210-1000	210-1000	220-990
Concave Area (m <sup>2</sup> /in. <sup>2</sup> )	1.1/1705	1.1/1705	1.1/1705	1.1/1705	1.35/2093
Separating Area (m <sup>2</sup> /in. <sup>2</sup> )	1.54/2390	1.54/2390	1.54/2390	1.54/2390	4.0/6200
Discharge Grate Area (m <sup>2</sup> /in. <sup>2</sup> )	0.36/555	0.36/555	0.45/698	0.45/698	n/a
<b>CLEANING</b>					
Front Chaffer (m <sup>2</sup> /in. <sup>2</sup> )	0.5/801	0.5/801	0.5/801	0.5/801	0.6/930
Front Chaffer Extension (m <sup>2</sup> /in. <sup>2</sup> )	N/A	N/A	0.8/1224	0.8/1224	--
Chaffer (m <sup>2</sup> /in. <sup>2</sup> )	2.5/3824	2.5/3824	2.5/3824	2.5/3824	3.06/9393
Sieve Area (m <sup>2</sup> /in. <sup>2</sup> )	2.1/3255	2.1/3255	2.1/3255	2.1/3255	2.64/4092
Total Cleaning Area (m <sup>2</sup> /in. <sup>2</sup> )	5.1/7905	5.1/7905	5.9/9145	5.9/9145	6.27/9719
Cleaning Fan Speed (rpm)	620-1350	620-1350	620-1350	620-1350	550-1350
<b>GRAIN HANDLING</b>					
Grain Tank Size (L/bu.)	10600/300	10600/300	14100/400	14100/400	11000/300
Unloading Auger Length (m/ft.)	6.9/22.5, 7.9/26, or 8.7/28.5	6.9/22.5, 7.9/26, or 8.7/28.5	6.9/22.5, 7.9/26, or 8.7/28.5	6.9/22.5, 7.9/26, or 8.7/28.5	7.05/23.5
Unloading Rate (L/sec. / bu./sec.)	116.3 / 3.3	116.3 / 3.3	135 / 3.8	135 / 3.8	115/3.3

S760 S770 S780 S790 T670

**RESIDUE MANAGEMENT**

Deluxe Residue – Manual Adjust Vane Tailboard, Fine Cut Chopper (44 knives), Integrated Chaff Spreader	■	■	■	■	
Deluxe Residue – In-cab operator controlled PowerCast™ Powered Tailboard with Wind Compensation, Fine Cut Chopper (44 knives), Integrated Chaff Spreader	■	■	■	■	
Intermediate Residue – In-cab operator controlled Advanced PowerCast™ Powered Tailboard, Extra Fine Cut Chopper (100 knives), Integrated Chaff Spreader		■	■	■	
Premium Residue – In-cab operator controlled Advanced PowerCast™ Powered Tailboard with Wind Compensation		■	■	■	
Fine Cut Chopper (44 knives), Integrated Chaff Spreader with Overshot Beater, Chop Straw & Spread Chaff or Drop Straw & Spread Chaff					
Premium Residue – In-cab operator controlled Advanced PowerCast™ Powered Tailboard with Wind Compensation				■	
Extra Fine Cut Chopper (100 knives), Integrated Chaff Spreader with Overshot Beater, Chop Straw & Spread Chaff or Drop Straw & Spread Chaff					

**TRACKS**

36 inch John Deere Tracks (MI)		■	■	■	
30 inch John Deere Tracks (MI)		■	■	■	
24 inch John Deere Tracks (MI)		■	■	■	

**FRONT TYRES**

520/85R42 157A8 R-1 Dual (FS/GY)	■	■			
520/85R42 162A8 R-2 Dual (FS/GY)	■	■	■	■	
VF 520/85R42 CFO 177A8 Duals (MI/FS)	■	■	■	■	
580/85R42 166A8 R-1W Dual (FS/GY/MT)	■	■	■	■	
650/85R38 173A8 R-1W Dual (FS/FS/MI)	■	■	■	■	
800/70R38 RIW 173D (FS/GY)	■	■			
VF 800/70R38 CFO 193B R-1W (FS)	■	■	■	■	
LSW 800/55R46 190D R-1W (GY)	■	■	■	■	
IF 900/65R32 CFO 191A8 R-2 (GY)	■	■	■	■	
VF 900/60R32 CFO 193B R-1W (FS)	■	■	■	■	
LSW 1100/45R46 CFO 190A8 R-1W (GY)	■	■	■	■	
LSW 1250/35R46 CFO 195D R-2 (GY)	■	■	■	■	
800/65R32 (MI/MT)					■
IF800/70R32 CFO (MI)					■
900/60R32 (MI)					■
IF800/65R32 CFO (MI)					■
800/70R32 CHO (MT)					■

**REAR TYRES**

600/70R28 161A8 R-1W (FS/GY/MT)	■	■			
620/75R26 166A8 R-1W (FS/GY)	■	■			
VF 620/75R26 172B R-1W (FS)	■	■	■	■	
VF 620/70R26 RIW 173A8 (MI)	■	■	■	■	
LSW 710/60R30 177A8 R-1W (GY)	■	■	■	■	
VF 710/65R26 177D R-2 (GY)	■	■	■	■	
750/65R26 166A8 R-1W (FS/GY/MT)	■	■	■	■	
VF 750/65R26 177B R-1W (FS)		■	■	■	
VF 750/65R26 CFO+ RIW 180A8 (MI)	■	■	■	■	
VF 520/80R26 Cerexbib2 (MI)					■
540/65R30 (MT)					■
600/65R28 (MT)					■



This literature has been compiled for worldwide circulation. While general information, pictures and descriptions are provided, some illustrations and text may include finance, credit, insurance, product options and accessories NOT AVAILABLE in all countries or regions. In some countries, products and accessories may require modifications or additions to ensure compliance with the local regulations of those countries. PLEASE CONTACT YOUR LOCAL DEALER FOR DETAILS. John Deere reserves the right to change specification and design of all products described in this literature without notice. John Deere's green and yellow colour scheme, the leaping deer symbol, and JOHN DEERE are trademarks of Deere & Company. All photography and illustrations contained herein are copyrighted assets of Deere & Company.

[JohnDeere.com.au](http://JohnDeere.com.au)  
[JohnDeere.co.nz](http://JohnDeere.co.nz)